

# 24" DEEP GLASS DOOR BACK BAR COOLER



EBB90G-24

EBB Series



### Refrigeration System

- Side mounted, self-contained and fully detachable Blizzard R290 condensing unit uses environmentally friendly, EPA-compliant R290 refrigerant with zero (0) Ozone Depletion Potential (ODP) and three (3) Global Warming Potential (GWP). Blizzard R290 is easily replaceable and requires no on-site brazing.
- Electronically commutated (ECM) fan motors achieve rapid cooling with less energy consumption.
- Full-length air duct ensures optimal cold air circulation.
- Time-initiated and temperature-terminated auto defrost cycle for seamless operation.
- Large capacity, corrosion-resistant condenser and evaporator coils.
- Self-maintaining, energy-efficient condensate drain pan requires no external drains or electric heaters.
- High performance, auto-reverse condenser fan motor supports compressor ventilation and condenser coil cleaning.
- Pre-wired and ready to plug, 115V/60Hz/1Ph, NEMA 5-15P.

### Cabinet Construction

- Heavy duty stainless steel countertop with textured laminate, black vinyl exterior.
- Open spaced interior with no walls between compartments.
- Galvanized steel interior walls and high quality stainless steel floor.
- 1 3/4" thick high density polyurethane insulation.
- Built-in caster thread receptacles.

### Lighting

- Shielded LED bar lighting with on/off switch provides bright, high color illumination at lower heat output.

### Doors

- Low emissivity double glass panes reflect UV rays for efficient cooling.
- Black PVC door frames.
- Snap-in magnetic door gasket make cleaning and replacement an easy process.
- High strength, die-cast door handles.
- Pre-installed door locks keep your items safe from theft.

### Shelving

- Two epoxy coated, steel wire shelves per section.
- Height adjustable stainless steel clips.

### Temperature Control

- Multi-function digital controller with easy to read LED display.
- Factory preset temperature, 35°F.
- Temperature setting range from 33°F to 54°F.
- Audible overheat protection alarm for compressor and condenser coil.

### Options

- Additional shelving.
- 3" or 5" swivel casters with locks.
- 3.5" – 6" height-adjustable and interchangeable legs.



Type	Doors	Capacity Cu. Ft.	12 oz. Cans	12 oz. Bottles	Shelves	Refrigerant	HP	Power V-Hz-Ph	Amps	Crated Weight	Exterior Dimensions		
											L	D	H*
REF	3	28	980	609	6	R-290	1/3	115-60-1	2.5	455 lbs	89.25"	24.5"	37.25"

(†)Based on evaporating temperature of 23°F (-5°C) & condensing temperature of 131°F (55°C). (‡) Product capacity is calculated based on standard industry figures. (\*) Reference plan view for clarification on caster/unit height. If dimensions and capacity are critical, please contact Everest Refrigeration. Blizzard R290 replacement is at the sole discretion of Everest Refrigeration. Specifications subject to change without notice.

# 24" DEEP GLASS DOOR BACK BAR COOLER



## EBB90G-24

## EBB Series

### DIMENSIONAL DATA

External Dims.	L	89.25 in.
	D	24.5 in.
	H*	37.25 in.
Crated Weight	455 lbs.	
Doors/Drawers/Lids	3	
Max Weight Support	-	

### STORAGE DATA

Net Capacity Cu. Ft. †	28
Shelves	6
Barrels	-
20 oz. Bottles	-
12 oz. Bottles	609
12 oz. Cans	980
8" Mugs	-
# of Pans (Top)	-
# of Pans (Drawer)	-
Dividers	-
Trays	-

### ELECTRICAL DATA

Voltage	115-60-1
Full Load Amperage	2.5A
Feed Wires w/ Ground	3
Cord Length	9ft
NEMA Plug Type	NEMA 5-15P

### REFRIGERATION DATA

Compressor	Side
Refrigerant	R-290
Compressor HP	1/3
BTU/HR †	2311

### KEY

<b>D</b>	Door	<b>R</b>	Refrigerator
<b>L</b>	Lid	<b>REF</b>	Refrigerator
<b>H</b>	Half Door	<b>F</b>	Freezer
<b>FD</b>	Full Door	<b>FRZ</b>	Freezer
<b>SD</b>	Solid Door	<b>DUAL</b>	REF/FRZ Combo
<b>GD</b>	Glass Door	<b>DR</b>	Drawer

	Elevation	Right	Plan	3D	Back

### PLAN VIEW

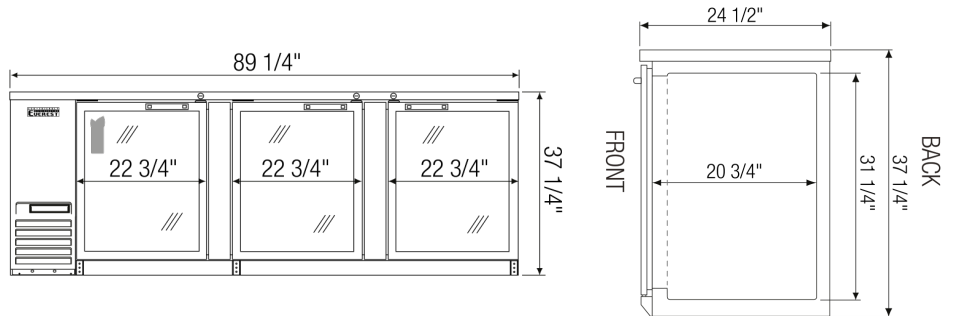

### FRONT

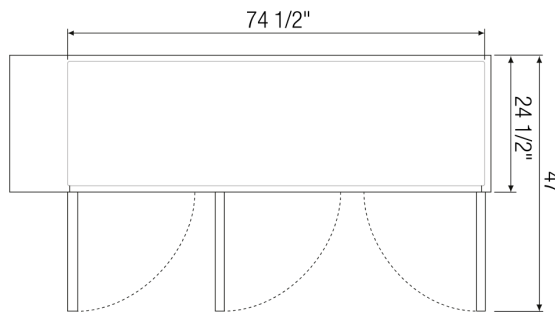

### TOP

### SIDE

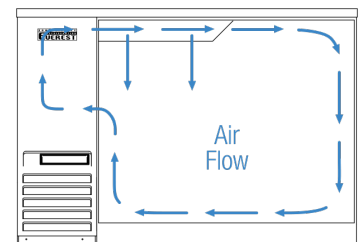

### AIRFLOW

### ACCESSORIES & OPTIONS

- Additional Shelving - Contact Everest Refrigeration for more information.
- AJL03-00 - Interchangeable Leg for Caster (Optional)
- CASA3-02 - 3" Overall Height Caster Assembly - (3) Front (3) Rear
- CASA5-02 - 5" Overall Height Caster Assembly - (3) Front (3) Rear

(†)Based on evaporating temperature of 23°F (-5°C) & condensing temperature of 131°F (55°C). (‡) Product capacity is calculated based on standard industry figures. (\*) Reference plan view for clarification on caster/unit height. If dimensions and capacity are critical, please contact Everest Refrigeration. Blizzard R290 replacement is at the sole discretion of Everest Refrigeration. Specifications subject to change without notice.