

**COMPETITOR SERIES®**

**C-CR24**

**C-CR36**

**C-CR48**

# CHAR-ROCK BROILERS

- Reversible heavy duty cast iron cooking grates with angled sides for flat or sloped positions
- Cast iron grates underneath cooking grates to support char-rocks and proper airflow
- Manually controlled cooking zones
- 35,000 BTU per “U” shape burner
- Removable, full width slide out waste tray
- Beautiful ergonomic design and easy to clean
- High polished, stainless steel exterior and chrome temperature knobs
- (4) adjustable stainless steel feet
- Comes standard as Natural Gas with L.P orifice kit for in-field conversion
- Migali Industries® Protection Plan: 2 Year Parts & Labor Warranty

MODEL	BURNERS	TOTAL BTU NG / LP	BTU PER BURNER NG / LP	IN TAKE TUBE PRES- SURE (W.C.) NG / LP	NOZZLE NO. NG / LP	IGNITION	VALVE TYPE	WORKING AREA W X D	EXTERIOR DIMENSIONS W X D X H	PACKAGING DIMENSIONS W X D X H	WEIGHT	PACKAGED WEIGHT
C-CR24	2	70,000	35,000	4 / 10	#36 / #50	Manual	Pilot Light	23.9 x 20.2	24 x 27.6 x 15.2	26.8 x 29.9 x 18.2	137 lbs.	168 lbs.
C-CR36	3	105,000	35,000	4 / 10	#36 / #50	Manual	Pilot Light	35.7 x 20.2	36 x 27.6 x 15.2	38.6 x 29.9 x 18.2	183 lbs.	238 lbs.
C-CR48	4	140,000	35,000	4 / 10	#36 / #50	Manual	Pilot Light	47.9 x 20.2	48 x 27.6 x 15.2	50.8 x 29.9 x 18.2	243 lbs.	313 lbs.

Gas Connection: 3/4" NPT on the right

Clearance for combustible work area: 6" rear & 15" sides - Do Not Store Combustibles Underneath Unit

NOTE: Altitudes over 2,000 feet may need high latitude orifice adjustments to deliver BTU output listed

**FOR COMMERCIAL USE ONLY**

NOTE: MIGALI® RESERVES THE RIGHT TO CHANGE SPECIFICATIONS WITHOUT NOTICE



TOLL FREE: 800.852.5292  
WEB: www.migali.com



# DIMENSIONAL DRAWINGS

C-CR24

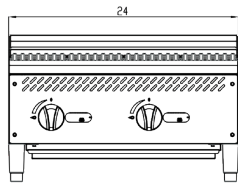

C-CR36

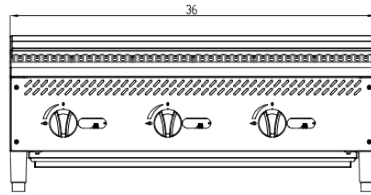

C-CR48

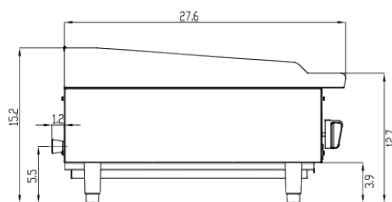
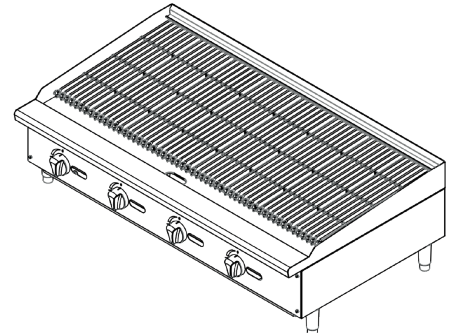
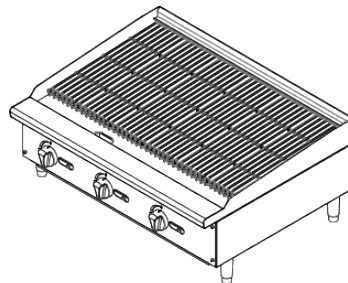
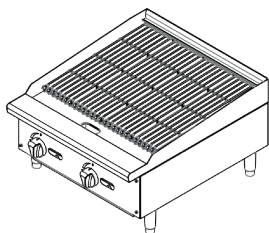
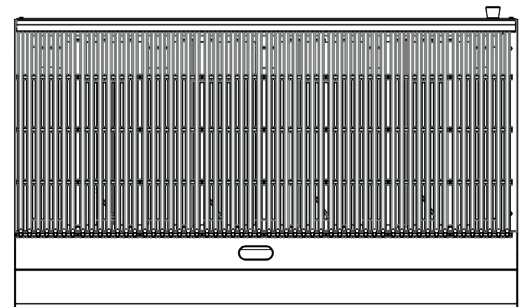
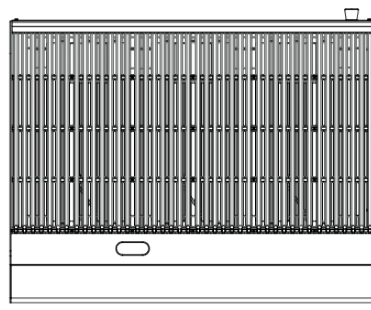
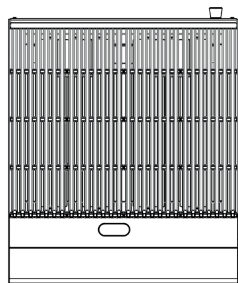
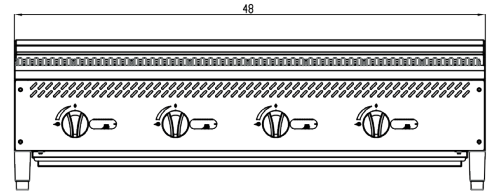

SIDE VIEW



MIGALI® REMAINS AN AMERICAN FAMILY COMPANY SINCE 1955