

COMPETITOR SERIES®

C-CB48-HC

C-CB52-HC

C-CB52-60-HC

C-CB72-HC

C-CB72-76-HC

REFRIGERATED CHEF BASES

- Beautiful ergonomic appearance
- Heavy duty top surface area
- Digital temperature controller and read-out
- All stainless steel exterior and interior
- Forced air refrigeration system
- Side mount compressor for enhanced efficiencies
- Recessed drawers handles
- Drawers accommodate 4" deep pans
- Stainless Steel, heavy-duty, self closing drawer slides
- Pre-installed casters
- (2) 6" locking casters & (2) 6" non-locking casters
- All Natural R290 Hydrocarbon Refrigerant
- US Department of Energy Certified
- Migali Industries® Protection Plan: 2 Year Parts & Labor Warranty, 5 Years Compressor Warranty

MODEL	DRAWERS	CAPACITY CU/FT	TOP WEIGHT LIMIT	NUM. OF (1/6) SIZE PANS*	H/P	AMPS	VOLTAGE	ENERGY CONSUMPTION KWH/24 HR	PLUG TYPE	TEMP RANGE	EXTERIOR DIMENSIONS W X D X H	INTERIOR DIMENSIONS W X D X H	PACKAGED DIMENSIONS W X D X H	WEIGHT	PACKAGED WEIGHT
C-CB48-HC	2	9.4	717 lbs.	15	1/7+	2.3	115/60/1	1.6	Nema 5-15P	+33° F (-) +41° F	48.4 x 32 x 26.2	36.2 x 25.6 x 16.7	51 x 33.9 x 27.6	221 lbs.	258 lbs.
C-CB52-HC	2	10.4	717 lbs.	18	1/7+	2.3	115/60/1	1.6	Nema 5-15P	+33° F (-) +41° F	52 x 32 x 26.2	40 x 25.6 x 16.7	51 x 33.9 x 27.6	230 lbs.	274 lbs.
C-CB52-60-HC	2	10.4	717 lbs.	18	1/7+	2.3	115/60/1	1.6	Nema 5-15P	+33° F (-) +41° F	60.5 x 32 x 26.2	40 x 25.6 x 16.7	63 x 33.9 x 27.6	234 lbs.	283 lbs.
C-CB72-HC	4	15	1084 lbs.	24	1/7+	2.3	115/60/1	1.8	Nema 5-15P	+33° F (-) +41° F	72.5 x 32 x 26.2	57.5 x 25.6 x 16.7	75 x 33.9 x 27.6	300 lbs.	364 lbs.
C-CB72-76-HC	4	15	1084 lbs.	24	1/7+	2.3	115/60/1	1.8	Nema 5-15P	+33° F (-) +41° F	76 x 32 x 26.2	57.5 x 25.6 x 16.7	78.6 x 33.9 x 27.6	309 lbs.	369 lbs.

* Pans not included

FOR COMMERCIAL USE ONLY

NOTE: MIGALI® RESERVES THE RIGHT TO CHANGE SPECIFICATIONS WITHOUT NOTICE



TOLL FREE: 800.852.5292
WEB: www.migali.com



DIMENSIONAL DRAWINGS

C-CB48-HC

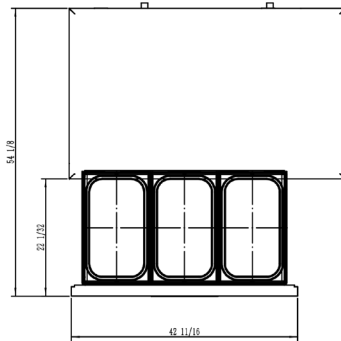
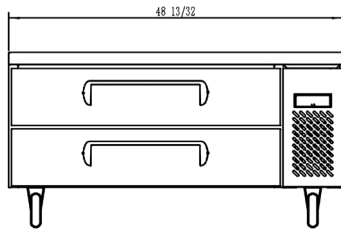

C-CB52-HC

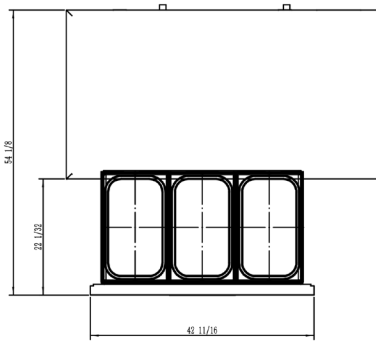
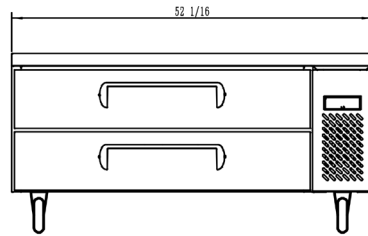

C-CB52-60-HC

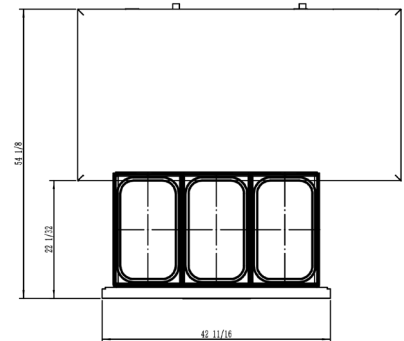
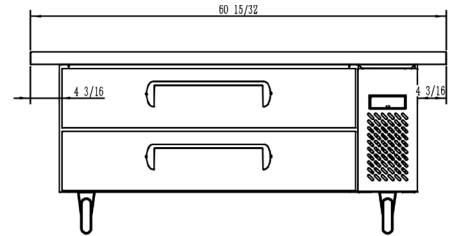

C-CB72-HC

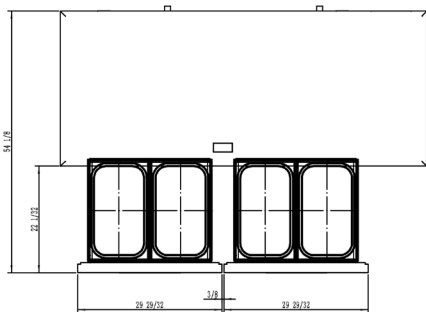
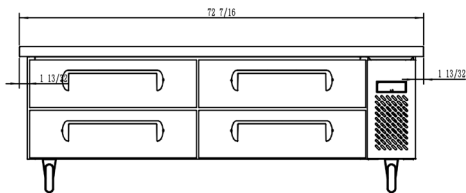

C-CB72-76-HC

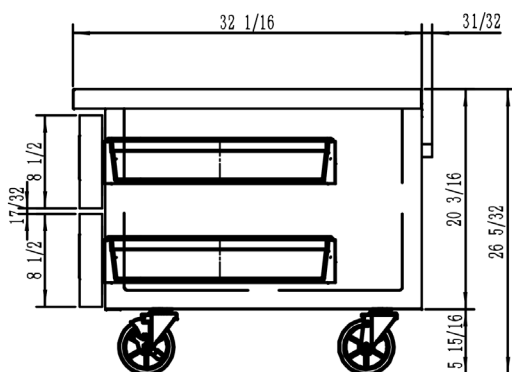
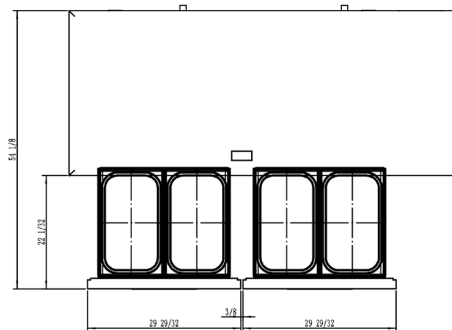
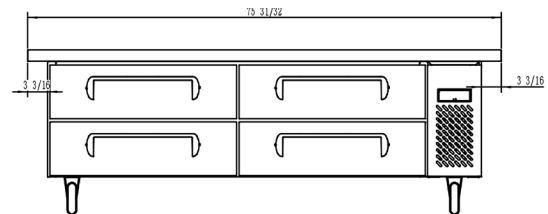

SIDE VIEW ALL SIZE MODELS



MIGALI® REMAINS AN AMERICAN FAMILY COMPANY SINCE 1955