

American Dish Service

INSTALLATION INSTRUCTIONS

Model ET-AF-M, ET-AF-3 (Pump Drain-Sustained Heat)

Available in 90, 120, 150-second Time Cycle

Undercounter, Single-Rack, Chemical Sanitizer, Dump & Fill Dishmachine

Listed by UL #E68594, NSF/ANSI 3, ASSE 1004 #933, LA Test Labs File M-780089, Mass. License P3-0111-306



If you have questions, call 800-922-2178 or visit our website at www.AmericanDish.com



DANGER

The electrical power supplied to this machine is an imminent hazard that could result in severe bodily injury or death if not properly installed or hooked up correctly. When working in the control box or on electrical parts, always disconnect power and tag-out before servicing. Replace cover to control box and other protective covers when finished servicing this equipment.



CAUTION

READ Manufacturer’s Manual before Using this Product. For your safety read and observe all cautions shown throughout these instructions. While performing installations described in this booklet, wear approved Personal Protective Equipment, including Safety Eye-Wear.

CHEMICALS— There are potentially hazardous situations when working with industrial cleaning chemicals for dishmachines. See chemical manufacturer’s safe practices and MSDS sheets for handling and installing chemicals and supply containers.



WARNING: Cancer and Reproductive Harm – www.P65Warnings.ca.gov

NOTICE

#1 BEFORE YOU BEGIN— American Dish Service provides this information as a service to our customers. Keep all instructions for future reference. ADS reserves the right to alter or update this information at any time. Should you desire to make sure that you have the most up-to-date information, we would direct you to the appropriate document on our web site: www.americandish.com. Set out below are the specifications and requirements that you must use and follow to properly install the type or types of equipment listed above. It is your obligation as the customer to ensure that the machine is installed safely and properly, and when completed, the machine is left in proper and safe working order. Electrical, Plumbing, and Chemical hookup should be performed by a qualified professional who will ensure that the equipment is installed in accordance with all applicable Codes, Ordinances, and Safety requirements. Failure to follow the installation instructions could void the warranty. ADS assumes no liability or control over the installation of the equipment. Product failure due to improper installation is not covered under the ADS Warranty.

#2 FLUSH OUT—Do not install spray arm until machine is flushed with water. When this machine is turned on, , first fill by pushing and holding the button marked FILL until water inside the pan reaches the water level decal on the outside of the pan, then push the button on front door marked START to complete one cycle. Do this before installing the spray arm. Dump the flush water out before installing spray arm by pushing the button marked DRAIN. Draining the water will flush installation debris from the tank and pump; this prevents damage to spray arm bearing.

#3 WATER HEATERS— or boilers must provide the minimum temperature of 120F degrees required by the machine listed above, which has a minimum demand of 60 gallons per hour. The recommended temperature range for optimal performance is 130-140F-degrees. These specifications are for the dishmachine only, which typically accounts for 70% of a restaurant’s hot water demand.

#4 IMPORTANT—The model of dishmachine listed in this document must be installed with space around the outside to allow for servicing of the motor as well as a 4” space behind the machine from the wall. It should not be built into wooden cabinets.

#5 INSPECT FOR DAMAGE—If you receive a damaged dishmachine, do not sign “Clear” but write “damaged” on the documents.

#6 LOOSE ELECTRICAL CONNECTIONS—Damage to equipment can occur if the following precautions are not observed. Before connecting power to the machine, check all electrical terminals in the control box. Screws can loosen in transit. Loose connections on high amp load terminals such as the pump motor will cause wire burning and component damage during operation and will not be covered under ADS warranty.

#7 “CLEAN CIRCUIT” means the electrical circuit breaker for the dishmachine supplies no other outlets, machines, or lights. GFCI outlets are not recommended for commercial dishmachines; ADS recommends that a single-rack machine be installed with the wire connection (hard-wired) directly from the circuit breaker. If a plug and socket are used to provide electrical power to a dishmachine in a commercial kitchen, then according to electrical code it must be a GFCI, but not all GFCIs are the same. They must be rated for the draw of the circuit.

Reference NEC Article 210.8 GFCI Protection (B) Other Than Dwelling Units (2) Commercial and Institutional Kitchens. All 15 and 20A, 125V receptacles installed in kitchens, even those that do not supply the countertop surface, must be GFCI protected.

#8 This equipment is considered an item of heavy use. It is not rated for outdoor use.

ELECTRICAL SECTION



The electrical power supplied to this machine is an imminent hazard that could result in severe bodily injury or death if not properly installed or hooked up correctly

Electrical—ET-AF-M, ET-AF-3 w/Pump Drain, Sustainer Heater (120 volt, 20 amp)

A time cycle of 90-seconds is the shortest time available for this model and is compliant with NSF listing. To change to a longer time cycle, the entire cam timer assembly must be changed because of the motor gearing.

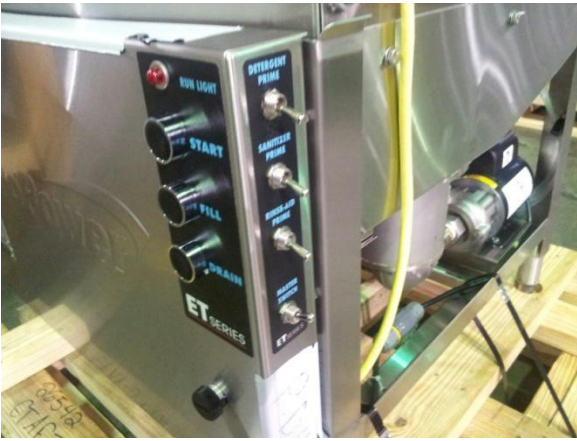

Showing controls on lower access door & drain pump

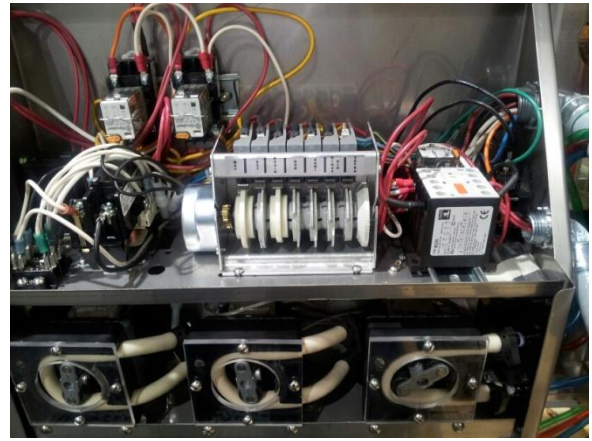

Control box with cover removed

The power supply for 120 volts, 20amps, shall consist of two #10-12-gauge wires and one suitable green ground wire. The 20 amp breaker or 20 amp fuse must be on a clean circuit for only this machine. ADS has provided a junction box with a 7/8" hole for the 1/2" conduit that will bring the building's electrical power to the machine. This junction box is attached to the lower frame of the machine, below the control box when the door is closed.

Remove the junction box cover, attach the conduit and connect a black 120 volt supply wire to the black wire in the junction box. Connect a white neutral supply wire to the white wire in the junction box. When powered up, test the neutral wire to a ground source with a voltmeter, it should read 0 to 6 volts. Test the black wire to a ground source, it should read 110-120 volts. Attach a building ground wire to the ground lug located in the junction box and tighten all wires. Replace the junction box cover.



Left is Start Relay, right is Heater Relay



Left is Drain Relay, right is Heater Contactor

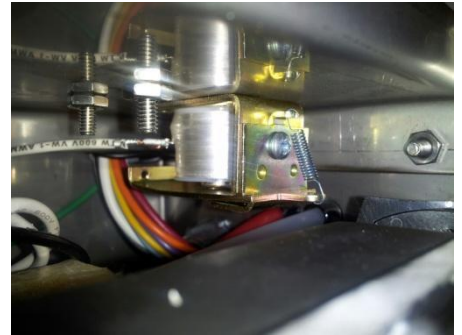

Optional buzzer for low chem. alarm



Power junction box for incoming 120v power

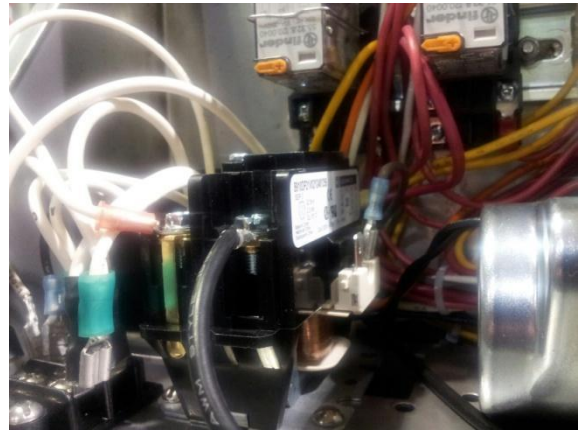

Wash motor contactor to the left of the cam timer motor



Heater terminal box in right front side of the pan



Heater box less cover, thermostat, element, float wires

THE SUSTAINER HEATER— is rated 500 Watts at 120v, and will draw approximately 4 amps. It is not designed to provide operational heat; the operational hot water must be provided by the building's primary water heater. The sustainer heater will not provide a rise to the incoming water temperature. Its purpose is to sustain the existing hot water sitting in the pan of the machine if it were to sit idle for periods of time. The sustainer will only operate when the pump motor is off.

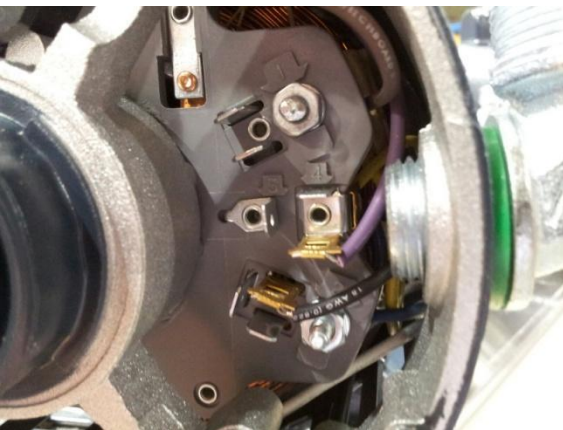

1.5 HP Motor, arrow 1 arrow 2 point to L1 & Neutral connect points



Optional chemical alarm pressure switch

IT IS RECOMMENDED THAT THIS EQUIPMENT BE INSTALLED USING A NEW CIRCUIT BREAKER. _____ This machine does not use a booster heater.

PLUMBING SECTION

NOTICE

#1 TANKLESS water heaters can be problematic for commercial dishmachines. The ADS model ET-AF dishmachine requires the full cycle amount of water (1.7 gallons) supplied within 7 seconds. It has been the experience of ADS that tankless supply systems require multiple units plumbed in sequence with a recirculation loop to achieve proper pressure and temperature.

Check with the tankless water heater manufacturer, they may recommend a storage tank to guarantee proper flow and line pressure to the machine. Failure to provide adequate water quantity, pressure and temperature to the machine will cause the machine to function improperly and is not the responsibility of ADS. Improperly installing ADS equipment in this manner could void the warranty. All costs associated with providing an adequate water supply to the machine is the sole responsibility of the user.

#2 HOODS—Follow all local plumbing and mechanical codes. IMC 2012, section 507.2.2 requires Type II hoods for all commercial dishwashers except where the heat and moisture loads are incorporated into the building's HVAC systems or dishwashing equipment designed with separate heat and moisture removal systems. An undercounter-type, chemical sanitizing dishwasher is rated at 6450 Btu/h by table 5E, ASHRAE Research Project #1362, 8/5/2008. **ADS DOES NOT SPECIFY BUILDING HVAC VALUES**

#3 DRAIN SIZE—The pump drain model uses a $\frac{3}{4}$ " reinforced drain tube 60" long. This tube should not be connected to a drain outlet higher than 18" from the floor. Do not connect a splice to lengthen the tube, this will create a clog in the drain line. If a longer tube is needed, replace with a single tube that runs the full length to drain. ADS does not recommend running a drain line further than 6' from the machine. Fasten the end of the drain tube to a drain line using adapters with a $\frac{3}{4}$ " barbed fitting and hose clamp. **NOTE:** Typical sink tail-pieces and traps are normally higher than 18" off the floor and are not approved drain access points for this model.





Showing 1/2" female pipe inlet, ball valve, y-line filter, H2O solenoid



ASSE approved vacuum breaker (backflow preventer)

Hot Water Connection

WATER HEATER—Flush the building's water lines before connecting to the dishmachine. Prior to connecting plumbing, level the machine by adjusting the feet at the bottom of each leg up or down. Water heaters or boilers must provide the minimum temperature of 120F required for this model of dishmachine, which demands a minimum of **60 GPH for ET-AF-PD H or ET-AF-3 PD H**. Temperatures above 150F degrees exceed the operational design limits for these models. These models cannot  be converted to high temp sanitizing by adding a booster.

INLET FLEX HOSE—Domestic style 1/2" flexible braided hose should not  be used to connect the dishmachine to plumbing. The ID of the plastic liner for this type hose restricts flow.

To use copper pipe plumbing, connect 1/2" male pipe thread (1/2" is the minimum allowable pipe size) of the hot water supply line to the 1/2" female pipe thread on the dishmachine's water inlet manifold.

SINK FAUCET— If the hot water line is also supplying the faucet of a pre-rinse sink or bar sink, install check valves on both cold and hot water inlets to the faucet— to avoid cooling the water by cross-connection in the mixing head of the faucet. The hot water inlet manifold is located behind the ET-AF control box door and to the left. The supply water must have a minimum of 120F degrees, but 130-140F degrees is recommended for best results.

Water Pressure for Filling

Minimum pressure needed at the machine is 15 psi DURING the fill. This is called FLOW pressure. STATIC pressure readings can be misleading and can drop to "0" during fill. With flow pressures below 15 psi, additional measures will be needed to resolve the problem. The first suggestion is to run 3/4" pipe directly from the water heater to the dishmachine. If the problem persists, install a pressure bladder tank used for domestic well water; a 5 gallon size would be a minimum, 10 gallon as a maximum. Another option is to order a cam timer with longer cycle times but this will reduce hourly production rates.

Simple Test For Water Pressure

Empty the water out of the machine by lifting the drain ball, push the manual FILL button while counting the seconds to fill back up to the water level decal. If it takes more than 20 seconds to fill, there is not enough building pressure to operate the machine properly.

Drain Requirements

To the rear of the machine is found the drain "Y" for the tube coming from the drain pump and the tank overflow. Do not remove the Y from the back. When the drain line is run down from 20" off the floor, the Y affords protection from overflow and leaking water solenoid conditions.



Showing stainless drain pump w/3/4" discharge tube



Drain "y" from overflow & drain pump, 48" drain tube



Recommended drain tube connection to building drain

CHEMICAL FEEDERS SECTION



WARNING

You must wear approved safety eye-wear before connecting chemicals. Read the chemical manufacturer's MSDS sheets. Chemicals can damage or corrode plumbing and stainless parts of the dishmachine. Do not run chemical lines over controls or plumbing. Always secure chemical lines and check regularly for leaks. If not properly handled, chemicals can cause serious bodily injury. In the event of chemical contact to skin or eyes; wash immediately with fresh water and seek medical attention.

INSTRUCTIONS FOR DE-LIME First empty all water out of the machine by pushing the drain button. After all water has emptied out, fill the machine with fresh water. After, turn off the master switch. Disconnect and protect one of the wires to the cam timer motor and roll the cam timer to mid-cycle on the wash section. Turn on the master switch to operate the pump motor. Add delime agent to the tank water. Repeat this first step again by draining, then refill and then run with fresh water. This will flush the machine, then turn off the master switch and connect the timer motor wire. **READ THE DIRECTIONS ON THE CONTAINER FOR CORRECT CONCENTRATION OF THE CHEMICAL. TYPICAL CONCENTRATION LEVELS 1:20 to 1:60.**

It is best to de-lime more often with milder acid solutions than waiting until there is heavy build up of white minerals, then trying to remove the build up with very strong acid concentrations. Using too strong of an acid solution or running it for very long periods of time will erode the metal of the impeller because it is spinning in the acid solution.



Warning decal about mixing chemicals



Impeller damaged from high acid solution

CHEMICAL FEEDER PUMPS

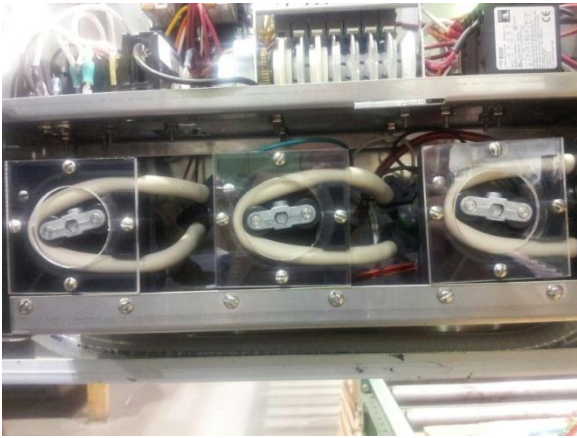

Showing deter, rinse, sanitizer internal chemical pumps



Chlorine test strips for measuring sanitizer

ADS provides three (3) peristaltic pumps to dispense liquid chemicals

Chemical feed lines are color coded "Red" Detergent, "Green" Sanitizer, "Blue" Rinse-aid

Pick-up tubes are provided for chemical product containers

Sanitizer (chlorine) concentrations should be set at 50 parts per million

Inspect the transfer tubing for any cuts or holes, keep them protected and secured out of the way



Showing chemical lines above sump

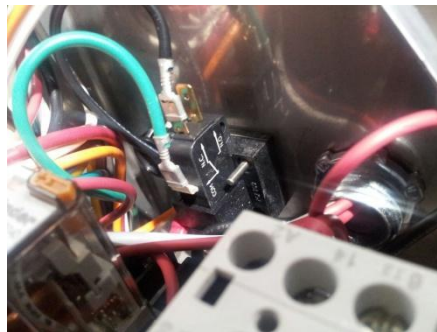

Optional Chemical Alarm switch



Chemical alarm barb adjusting screw *

TYPE OF CHEMICALS—Use only commercial grade low-energy chemicals. For proper operation, use non-foaming detergents and buffered sanitizer. Do not wash gold, pewter, silver, or silver-plate with chlorine based sanitizers. High concentrations of chlorine sanitizers and caustic detergents will cause damage to metals and welds. Do not exceed 50 parts-per-million (PPM) "free" or available chlorine. Any setting higher than 50 ppm will be dependent on local health requirements, however, the increased chlorine will result in higher corrosion of metal parts. Purpose-built ware-washing dispensers are needed to properly meter chemicals for wash and rinse. These dispensers are included with this model. Manually adding industrial chemicals to the dishmachine is unsafe and not approved.

CHEMICAL LINES—Place color coded tubes into proper chemical containers. The containers need to be as close to the machine as possible and at floor level. This may require shortening of the flexible chemical transfer tubes. On the side of the control box door, there are chemical prime switches. There is a decal identifying each switch. To prime chemicals, use these momentary prime switches, verifying that all three pumps rotate. If a chemical pump squeeze tube has taken a set (not allowing the pump to turn), manually free the pump by pulling on the discharge side (right-hand) of the squeeze tube while pushing the prime switch. Squeeze tubes should be replaced at least every six months.



WARNING

Containers: The ADS chemical delivery system is designed for 5 gallon pails of industrial low-energy chemical products. Always use chemical resistant safety gloves and safety goggles (indirect-vented or non-vented) when changing chemical buckets. Immediately report spills and refer to your chemical suppliers SDS safety data sheet or MSDS material safety data sheet for information if chemical come in contact with skin or eyes.

Any modifications to the chemical delivery system for smaller containers must include **Closed Loop Chemical Containers** (spill proof bottles) in a secured racking system. It is the responsibility of the user of the machine to purchase chemicals in spill proof containers. **FAILURE CAN RESULT IN SERIOUS INJURY.** Never place chemicals in open containers or containers that can be easily tipped over when moving or changing product. Failure to do so will void your ADS warranty.

CHEMICAL ADJUSTMENT—Chemical dispensing is controlled by a mechanical cam timer. All chemical products must be adjusted for the product’s concentration and local water conditions. It will be necessary to adjust initial factory settings (See below for Cam Timer Adjustment Section). Water softeners should be added to correct hard water conditions. Hard water is often treated with more expensive ware-washing chemicals, but it is more effective and less destructive to the metal to soften the water before it comes to the dishmachine.

AUDIBLE CHEMICAL ALARM OPTION—The optional chemical alarm (P/N 031-0326) uses a pressure switch with a barb fitting that extends from the control box and connects to the chemical line by means of a “t” fitting. The switch sends voltage to a buzzer located in the control box. Sensitivity is adjusted by an Allen wrench (5/64” or 2mm) to turn a screw located in the center of the barb (see photo above*). Remove the tube from the barb; turn the screw to the right for less sensitivity. Chemical buckets must be placed on the floor for the pressure switch to work.

VISUAL CHEMICAL INDICATOR—

ET-AF Chemical Flow Indicator

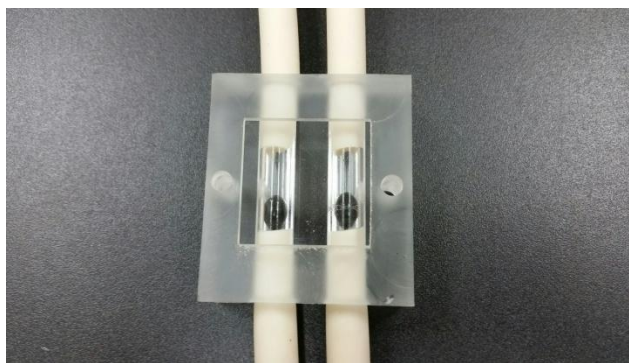

According to NSF/ANSI 3, section 5.19.3 and 5.19.5

“This machine must be operated with an automatic detergent feeder and, if applicable, an automatic chemical sanitizer feeder, including a visual means to verify that detergents and sanitizers are delivered or a visual or audible alarm to signal if detergents and sanitizers are not available for delivery to the respective washing and sanitizing systems. Please see instructions for electrical and plumbing connections located in this manual and in the feeder equipment manual.”

--a visual means to verify that detergents and sanitizers are delivered; or a visual or audible alarm to signal if detergents and sanitizers are not being delivered to the respective washing and sanitizing systems.

For ADS family models of ET-AF and the model ASQ, the chemical Flow Indicator (084-6403) is the visual means to indicate liquid is flowing in the feeder system for detergent and sanitizer. In each of the tubes machined through the clear plastic housing, there is a black colored marble (099-1008). Squeeze tube material (092-2000) is inserted in both upper and lower tube openings. These tubes are pushed into the holes of the housing and held in place by tension of the tube wall against the housing’s inner surface. When inserting the squeeze tubes into the housing, lubrication using dish soap is helpful.



When the top tube of the indicator is connected to the inlet side of the chemical peristaltic pump, liquid is drawn up through the supply tube of the chemical bucket. The liquid is drawn into the bottom of the Flow Indicator housing and lifts the black indicator marble upward in the visual chamber. This movement shows flow of the liquid in the tube. The tube with red colored liquid will indicate detergent flowing, the tube with clear liquid will indicate sanitizer (chlorine) flowing.

The operator should be informed that this movement of the marbles in the housing is the visual indication that chemicals are being delivered for the washing and sanitizing operations of the dishmachine. Management should be notified if there is no movement of the indicators.

CAM TIMER ADJUSTMENT SECTION

Timers are available with 7- or 8-cams. The cycle times are not adjustable. The cams of the timer are wheels whose positions are either fixed or adjustable. Each cam controls a specific machine function, as noted on the timer decal. Adjustable cams are comprised of two wheels held together at the hub. The perimeter of each wheel is divided into 180-degrees of high cam and 180-degrees of low cam. When one of these wheels is rotated on the hub in relation to the opposing wheel, the two lower cam segments can form a notch in the perimeter (see photo below right). Above each cam is a timer switch with a metal finger that rides along the outer edge of the cam. When the finger drops into the lower cam notch, the function of that cam starts.



Cam adjustment tool



Temperature indicator



Spray arm pressure tester # 088-1048

To widen the notch (length = time energized) or close the notch use the timer adjustment tool, which is provided and taped to the control box shelf. This tool has two raised buttons that fit into the holes on the side of each wheel. The factory sets the start of each function using the right-side wheel of the cam. TO ADJUST rotate only the left-side cam wheel. The left-side of the wheel controls the point when that specific functions ends. Factory settings are only initial settings, adjustments will be required for each chemical and the water fill time because water pressures will be different for every account.

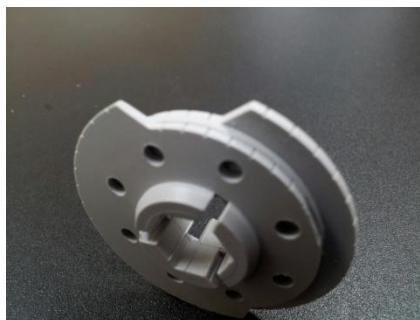

The left photo shows arrow is pointed at the left-side wheel of the cam which is used to lengthen or shorten the low cam or the time ON for the respective switch. Center photo shows high-cam & low-cam notch. Adjustable cams are colored either black or gray.

Looking at the front of the cams with the cam timer assembly sitting on its mounting base

#1 Cam: The white cam on the left is the master cam. It controls the total time of the cycle and is not adjustable.

#2 Cam: Continuing left to right, this black or gray cam controls detergent. The detergent cam is adjustable and should begin as soon as the wash action starts.

#3 Cam: This white cam controls the drain time and is not adjustable.

#4 Cam: The H2O or fill cam opens the water solenoid. Too little water will cause the pump to cavitate (surging). Overfilling does not allow the soiled wash water to fully drain between cycles, causing carry-over. Do

not move the right side of the cam wheel. Adjust the left-side of the cam wheel to close the water solenoid when the dishmachine reaches full spray arm pressure.

#5 Cam: This black or gray cam controls sanitizer. The sanitizer cam is adjustable. Set sanitizer concentrations at 50 parts per million. Monitor chlorine levels by using chlorine test strips. To Test—run a rack of dishes through a complete cycle, use the test strip to test water samples from the top of any glass.

#6 Cam: This black or gray cam controls rinse additive. The rinse-aid cam is adjustable.

#7 Cam: This cam is used to pause or “burp” the pump on the 3D-S, ES, 5AG-S, 5CD, and L Series. It is set at the factory but can be adjusted.

#8 Cam: Available on 2 1/2 minute timers only. Provides prewash/wash/rinse.

TUNING A DUMP & FILL MACHINE SECTION

Tuning is essential for proper cleaning; do not skip this IMPORTANT PROCEDURE

The key to understanding proper tuning is to realize that the drain sequence cannot be changed. It is a fixed time function and the regulator of the cycle between wash and rinse. Therefore, all tuning is accomplished by setting or adjusting the fill cam in relationship to the fixed drain cam. The goal of tuning is to eliminate all soiled wash water through the drain, before the drain closes. A sign that soiled wash water has exited the tank will be the typical hollow sound of a pump running without water.

It is at this point that the H₂O (FILL) cam should be adjusted so the water solenoid turns the fill water on. That function is controlled by the adjustment of the fill cam. For optimum results, allow the fill water to flush the interior of the machine for a few seconds before the drain closes. Once the drain is closed the fill cycle begins. Fill must continue until full spray arm pressure is reached. This can be verified with the use of a spray arm pressure tester (Kit #088-1048) attached where one of the end plugs are usually screwed into the lower wash arm. The tester gauge will indicate full spray arm pressure when the needle stops fluctuating and remains steady. Adjust the fill cam to turn the water OFF when this point of steady pressure is reached. It is important that the machine is not overfilled. Use just enough water to reach Full Spray-arm Pressure (FSP), no more than that is needed for proper operation.

Typical 90-second timer operation	[Pump shut off]-[*sanitizer here]
START [-----WASH 45-Seconds-----]	- [--DRAIN 15-Sec--] - [--30-sec to FILL and RINSE--] END
[*detergent here]	[-Fill until FSP is reached-]

If a pressure gauge tester is not available, an approximation of full spray arm pressure could be determined by the sound of the spray arms. There would be a typical continuous swishing sound of the water spraying. Again, when this sound is heard, that would be the point to turn the water OFF. Seven seconds of full spray arm rinse pressure is required by health code. In the event that air is trapped in the pump during fill, a vapor lock can occur where the pump is turning but there is no spraying.

If this vapor lock occurs, check incoming water temperature and reduce the temperature if it is above 140-150F. Operating temperature of 120F degrees is the minimum, 130-140F degrees is recommended. If the problem is caused by low water pressure to the machine, then see the Plumbing Section above to correct that condition. If vapor lock is still present, electrically stop or pause the pump to release air. This machine has a 7-cam timer, this pause feature is wired into the 7th cam from the factory.

FINAL INSTALLATION CHECK LIST

- 1 Check to be sure power is disconnected at the breaker and the control box is switched OFF.
- 2 The master switch is located on the side of the lower door, which houses the control box. Open wash cabinet door and remove all packaging, save all instructions for future reference.
- 3 Remove the white protective film from doors, front panel, and control box.
- 4 Check dishtable placement, if one is used with the dishmachine.
- 5 Turn on water supply. Check for leaks. Tighten connections if needed.
- 6 TO OPERATE— turn on the main power circuit breaker and switch the dishmachine master switch to ON position. Remove spray arm and manually fill the machine with water using the fill switch (labeled FILL). This switch is located on the front facing surface of the lower access door. Run one complete cycle by closing the door, push the start switch (labeled START). This first run will be the flush cycle, which removes installation debris from wash tank and pump.



Spray arm, base w/thumb screws



Standard ET-AF spray arm (081-6208)

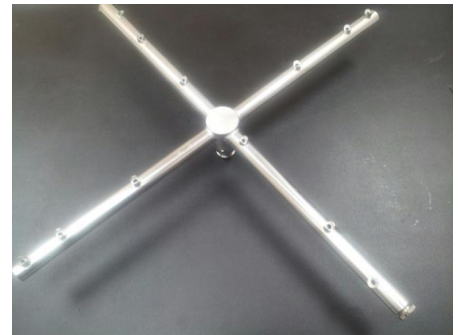

Cross arm for light glassware (081-6212)

- 7 AFTER FLUSHING—install the spray arm. *Failure to follow this flush procedure can damage the spray arm bearing.* Observe the water level decal. This decal is located on the outside of the pan next to the sump. This mark is the approximate level for initial fill. Verify incoming water temperatures 120F degrees minimum (130-140F degrees recommended).



Sustainer heater cover and pump filter system



Secondary basket for dumping, primary filter shown in place

- 8 PUMP FILTERS—Inspect the sump area and verify pump filters are in place. The primary filter is bolted in place and should not be removed by the end-users. If the secondary filter basket is used properly, this will avoid unnecessary cleaning of the primary filter (which should only be cleaned by qualified personnel). The

secondary filter basket is used to block the path for picks and straw's through the primary filter holes; it catches and holds solids. The secondary (loop handle) should not be removed before draining the machine. It should be removed and emptied only after the machine is completely drained—like the tray of a scrap box. Verify that chemical feed lines are in their proper container and that lines are primed. Post an operational wall chart close to the machine.



WARNING

Do not open doors while machine is in cycle. Doing so could result in serious bodily injury from spraying hot water and chemicals.

APPENDIX

000-0000-----ET-AF-PD-H Parts Manual

089-9349-----Service Manual

000-0000-----Brochure

089-9364-----Wall Chart

000-0000-----Wire Diagram

089-9379-----Installation Manual ET-AF-PDH

ADS WIRE CHART (LADDER) MODEL: ET PUMP DRAIN

CONNECT TO ELEC SUPPLY SOURCE
USING 12-10 AWG COPPER WIRE
120 VOLT
CIRCUIT PROTECTION: 20 AMP BREAKER
OR FUSE WITH A 20 AMP RATING

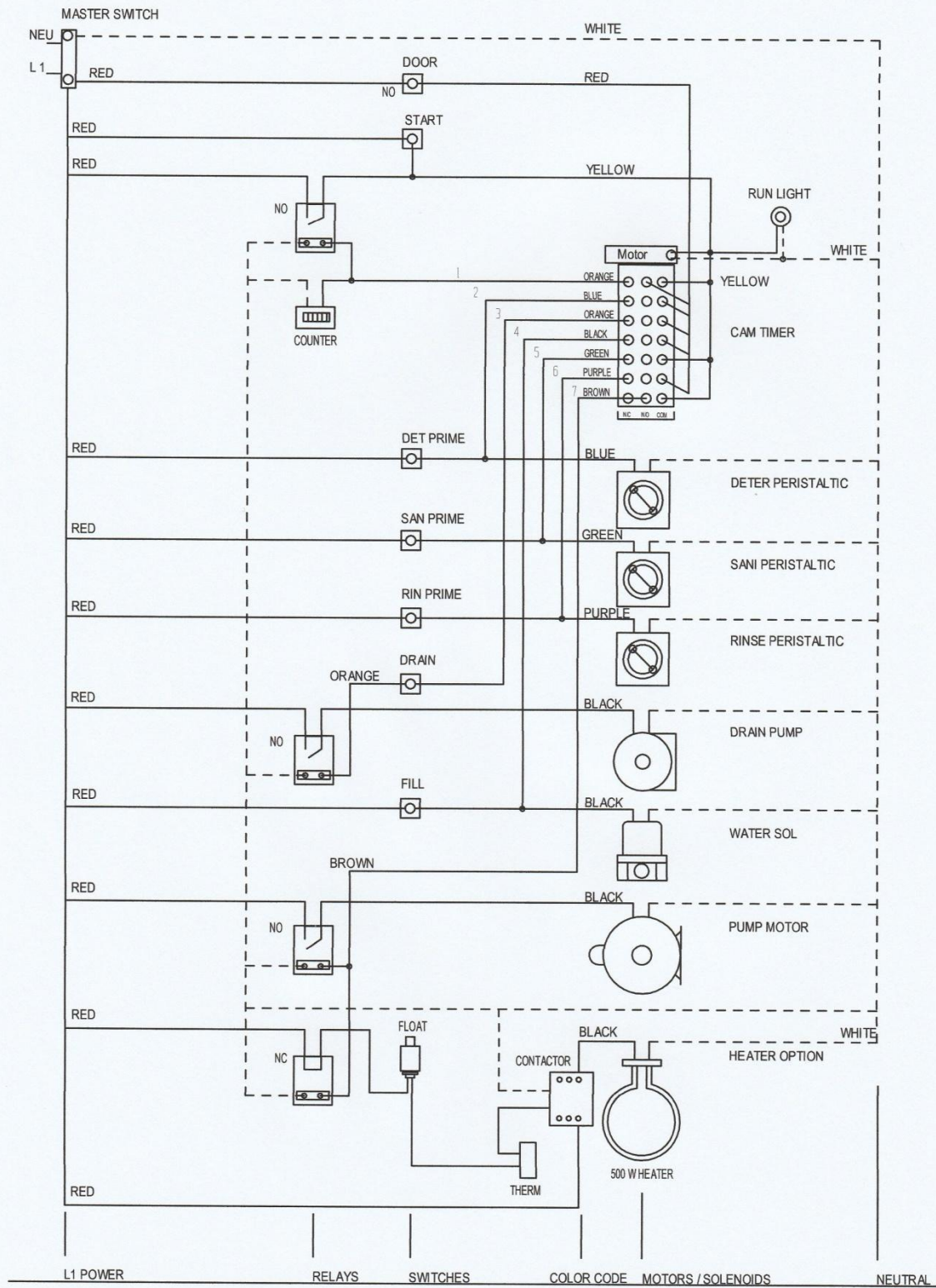

NOTES

WARNING!

This product is manufactured solely for **commercial** use. It is not to be used in residential installations of any kind. Doing so will immediately void all warranties. American Dish Service assumes no liability for such unintended uses.

**FOR PARTS &
SERVICE
MANUALS
GO TO**

www.americandish.com

**PRODUCTION FINAL INSPECTION
AMERICAN DISH SERVICE CORPORATION
DISHMACHINE TEST**

SERIAL # _____ MODEL # _____ DATE: _____

CHECKED:

- _____ 1 Drain Ball - seated properly
- _____ 2 No leaks around nuts & bolts
- _____ 3 Chemical pumps traced, through prime switches, for proper operation *

Detergent

Rinse Aid

Sanitizer

Prime _____

Prime _____

Prime _____

- _____ 4 Pump - free from leaks.
- _____ 5 Plumbing - free from leaks.
- _____ 6 Tight nuts and bolts
- _____ 7 Tight drain linkage.
- _____ 8 Spray arms rotate freely.
- _____ 9 Spray arm end plugs - secure.
- _____ 10 Spray arm pressure - 16 PSI minimum.
- _____ 1 Smooth door operation.
- _____ 2 Smooth rack operation.
- _____ 3 Nameplate properly installed and engraved.
- _____ 4 Decals properly installed and are straight.
- _____ 5 Overall machine operation is to standard.
- _____ 6 Overall machine cleanliness is to standard.
- _____ 7 General appearance of machine is free from scratches, dents, etc.

ELECTRICAL SAFETY

- _____ 8 Hi Pot Test - passed to standard
- _____ 9 Ground Test - passed to standard

I certify the above items have been checked and meet or exceed established American Dish Standards

Inspector

***CUSTOMER NOTE: Cam adjustment varies with chemical concentrations. Adjust factory settings accordingly.**